

RND GLASS ADAPTOR
05/29/2015

8 7 6 5 4 3 2 1

REVISIONS				
ZONE	REV	DESCRIPTION	DATE	APPROVED

D
C
B
A

D
C
B
A

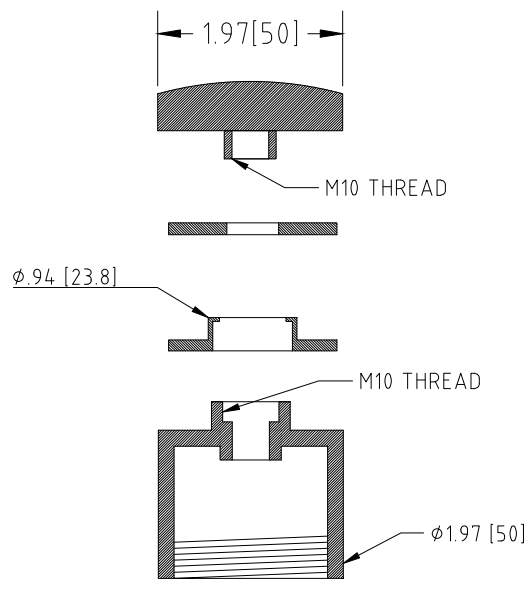
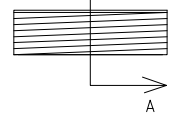
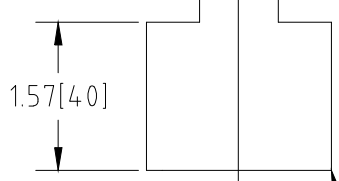
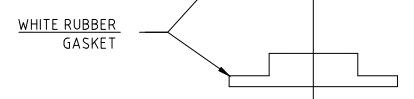
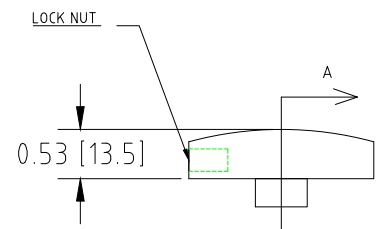

VIEW A-A
AVAILABLE IN 30MM & 40MM

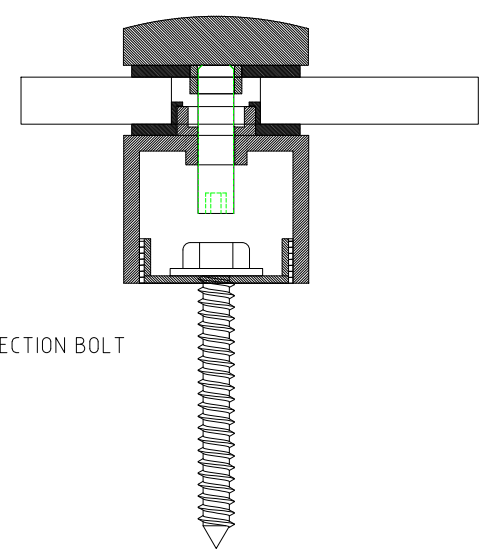
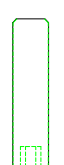

	RND GLASS ADAPTOR		
	INLINE DESIGN		
DATE: 05/29/2015	SCALE: 1:1	DWG NO.: GA0.000	REV: 3

8 7 6 5 4 3 2 1